



**L.T.F.**

## QLUX COB LED Series



### QLUXCOBI181893016KWD-PH1CH Single Channel Dim to Warm Chip on Board LED

## QLUX COB



<b>Size</b>	18mm x 18mm
<b>LES</b>	14 mm (OD)
<b>Maximum Voltage</b>	≈ 34V
<b>Typical Power</b>	≈ 24W
<b>Typical Efficacy</b>	≈ 90 lm/W
<b>CCT</b>	3000K-1600K Dim to Warm
<b>Typical CRI, R9</b>	CRI=98, R9=91
<b>Maximum Lumens</b>	≈ 2170 lm



**RoHS**



LTF's U.S. Patented QLUX Series COB LEDs offer endless possibilities for lighting OEMs and designers. With high efficacy, superior color rendering and best color over angle performance built into all QLUX LED light sources, QLUX COBs let you dial in the perfect illumination for any architectural lighting application.

### FEATURES

- Dim to Warm feature enables light to transform from vibrant 3000K CCT down to a warm, cozy 1600K as it is dimmed.
- Superior color rendering performance throughout CCT and dimming ranges.
- Excellent color uniformity and best color over angle with TIR optics.
- Customizable CCT and dimming curve options.
- Proven reliability; LM-80 9,000 hours completed.
- Cost effective.
- Low thermal resistance with long time reliability.

### APPLICATIONS

- Human-centric lighting
- Circadian lighting
- Architectural lighting
- Spot lights
- Down lights
- Pendants

### SPECIFICATIONS

Model	CCT (Dim to Warm)	Typ. Power	Typ. Current	Typ. Voltage	Luminous Flux	Typ. CRI	Typ. R9
QLUXCOBI181893016KWD-PH1CH	3000K-1600K	24W	700mA	34V	2170 lm	98	91



**L.T.F.**

**QLUX COB LED Series**

**QLUXCOBI181893016KWD-PH1CH**  
**Single Channel Dim to Warm Chip on Board LED**

**MECHANICAL SPECIFICATIONS**

Board Dimensions	Light Emitting Surface
17.75mm x 17.75mm	14mm (OD)

**Recommended COB Holder:**

COB connector  $\varnothing$  35 mm for LED array  
 17.85 x 17.85 mm

**Part Number: 47.360.1040.50**

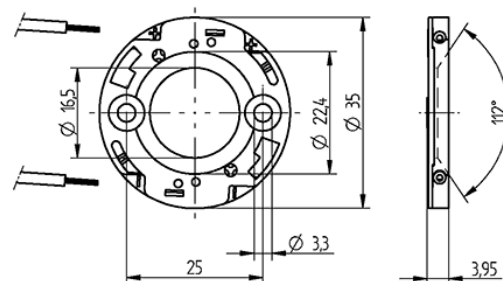
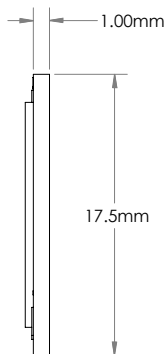
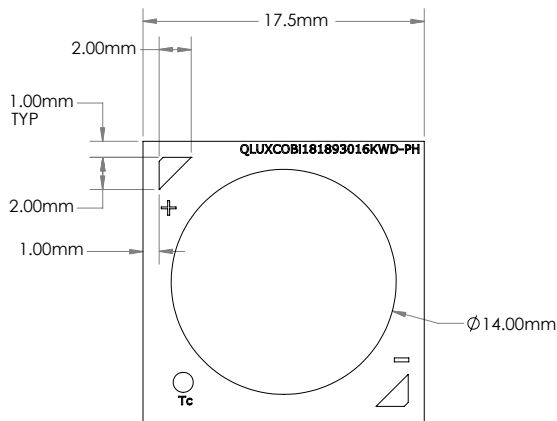

[View on BJB.com >](http://www.BJB.com)

**ABSOLUTE MAXIMUM RATINGS**

Parameter	Maximum Rating
Allowable Reverse Current ( $I_R$ )	20mA
LED Junction Temperature ( $T_J$ )	130°C
Storage Temperature	-40°C to +125°C
Operating Case Temperature ( $T_C$ )	100°C
Soldering Temperature	380°C or lower, 5 seconds max.
Maximum Total Drive Current	900 mA
Maximum Power	26W

**POLAR RADIATION PATTERN**

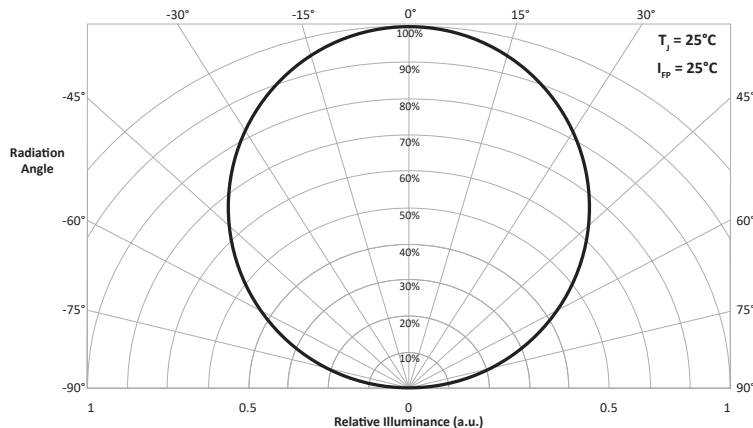



**L.T.F.**

**QLUX COB LED Series**



**QLUXCOBI181893016KWD-PH1CH**  
**Single Channel Dim to Warm Chip on Board LED**

**SPECTRORADIOMETRIC CHARACTERISTICS**

3000K CCT (700mA, No Dimming, T<sub>j</sub>=25°C)

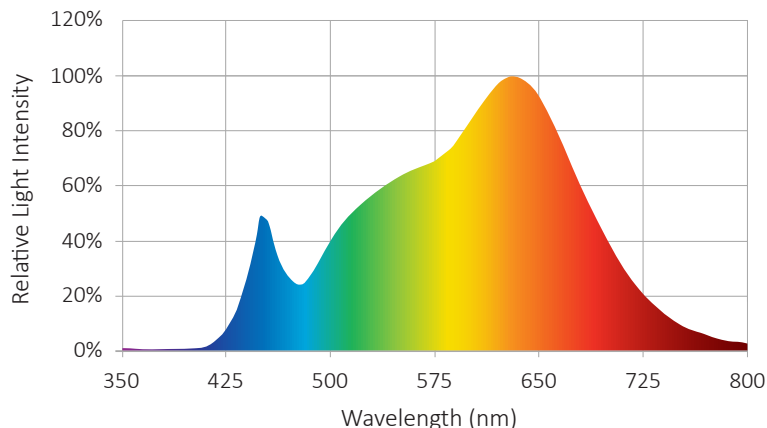

**CCT:** 3095K  
**Luminous Flux:** 2172.38 lm  
**Efficacy:** 90.1 lm/W  
**Nominal CCT:** ANSI\_F3000K  
 x0=0.4400 y0=0.4030  
**Chromaticity Coordinates:**  
 x=0.4289 y=0.3985 u'=0.2477 v'=0.518  
**Chromaticity Difference:** -0.00109 Du<sub>v</sub>  
**Dominant Wavelength:** 581.0 nm(E)  
**Peak Wavelength:** 630 nm

**CRI TEST RESULTS**

3000K CCT (700mA, No Dimming, T<sub>j</sub>=25°C)

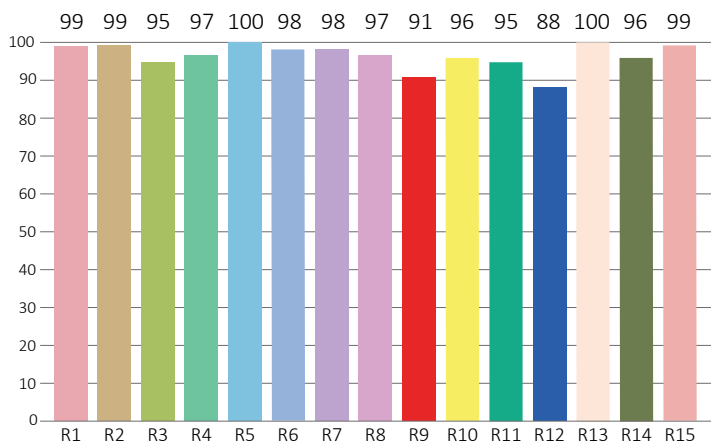

**Color Rendering Index (CRI):** Ra = 97.9  
**Colour Fidelity Index:** Rf = 95  
**Gamut Index:** Rg = 102  
**Purity:** 0.4862  
**Color Ratio:** Kr=42.5% Kg=48.7% Kb=8.8%  
**Color Tolerance (SDCM):** 5.8  
**Bandwidth:** 170.5 nm  
**Radiant Flux:** 8.108 W  
**Photosynthetically Active Radiation (PAR):** 7.54 W  
**Photosynthetic Photon Flux (PPF):** 37.18 μmol/s

R1=99	R2=99	R3=95	R4=97	R5=100	R6=98	R7=98	R8=97
R9=91	R10=96	R11=95	R12=88	R13=100	R14=96	R15=99	Re=97



**L.T.F.**

**QLUX COB LED Series**



**QLUXCOBI181893016KWD-PH1CH**  
**Single Channel Dim to Warm Chip on Board LED**

**IES TM30-18 COLOR RENDERING REPORT**

3000K CCT (700mA, No Dimming,  $T_j=25^\circ\text{C}$ )

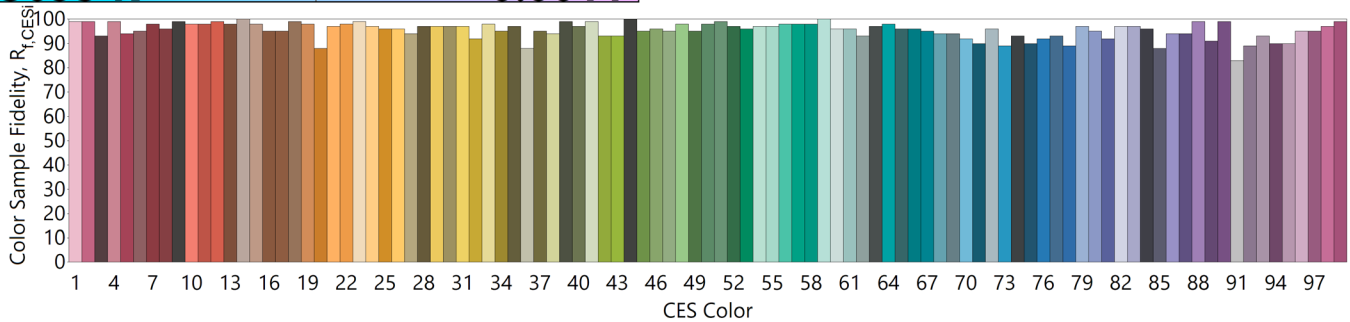
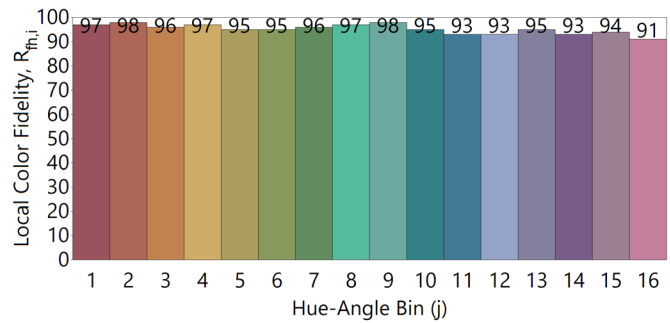
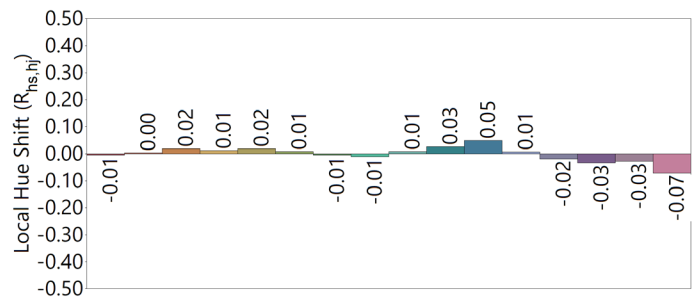
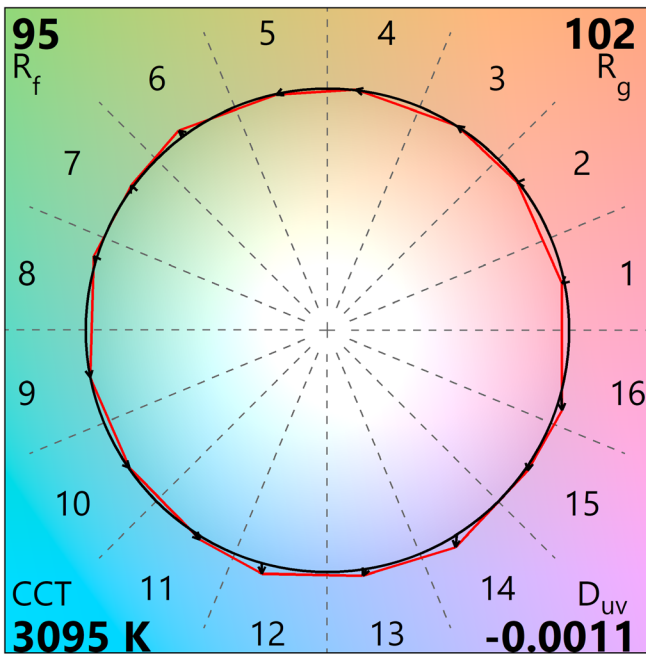
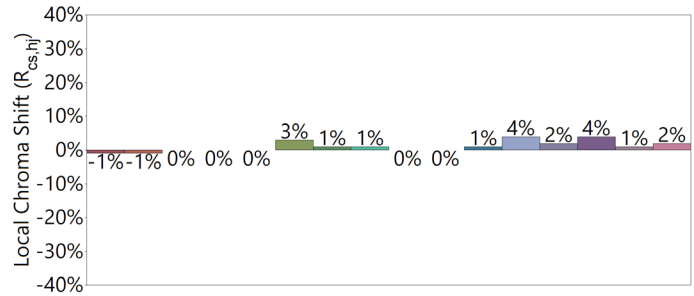
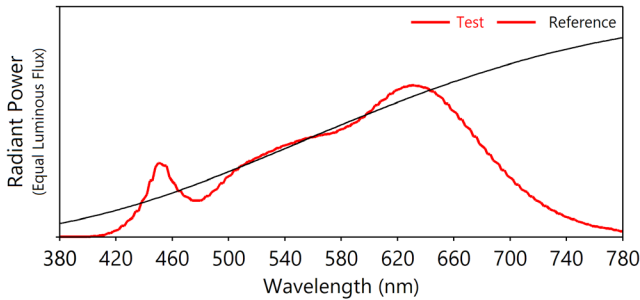



**L.T.F.**

**QLUX COB LED Series**



**QLUXCOBI181893016KWD-PH1CH**  
**Single Channel Dim to Warm Chip on Board LED**

**SPECTRORADIOMETRIC CHARACTERISTICS**

1800K CCT (10mA, Full Dimming, T<sub>j</sub>=25°C)

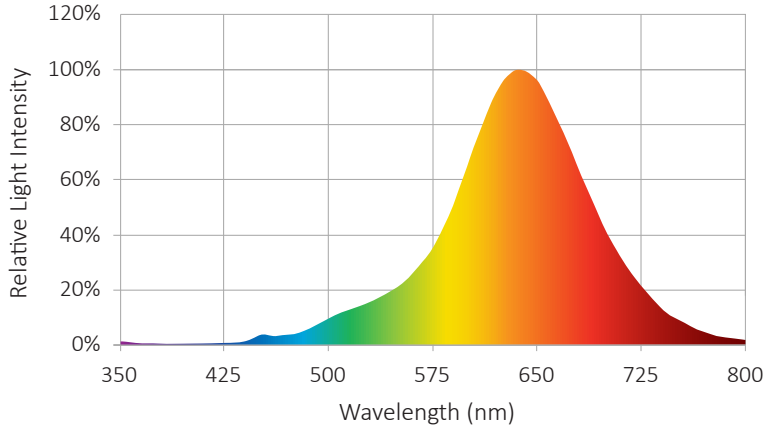

**CCT:** 1649K  
**Luminous Flux:** 20.66 lm  
**Efficacy:** 68.9 lm/W  
**Nominal CCT:** ANSI\_F2700K  
 x0=0.4590 y0=0.4120  
**Chromaticity Coordinates:**  
 x=0.5668 y=0.4012 u'=0.3393 v'=0.5405  
**Chromaticity Difference:** -0.00021 Duv  
**Dominant Wavelength:** 591.0 nm(E)  
**Peak Wavelength:** 640 nm

**CRI TEST RESULTS**

1800K CCT (10mA, Full Dimming, T<sub>j</sub>=25°C)

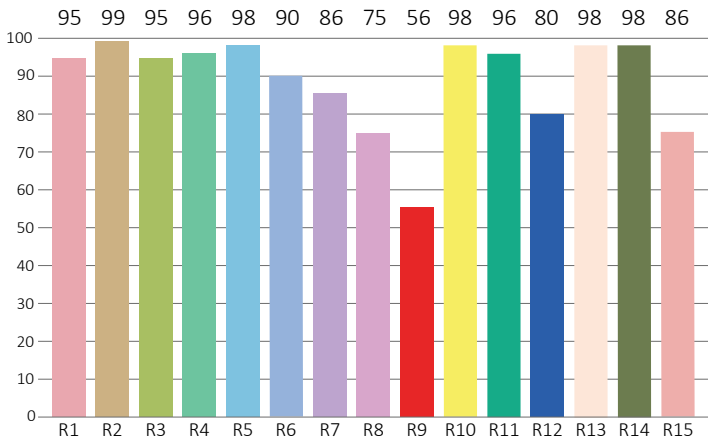

**Color Rendering Index (CRI):** Ra = 91.6  
**Colour Fidelity Index:** Rf = 91  
**Gamut Index:** Rg = 95  
**Purity:** 0.9158  
**Color Ratio:** Kr=64.0% Kg=32.4% Kb=3.6%  
**Color Tolerance (SDCM):** 71.7  
**Bandwidth:** 103.4 nm  
**Radiant Flux:** 0.102 W  
**Photosynthetically Active Radiation (PAR):** 0.09 W  
**Photosynthetic Photon Flux (PPF):** 0.48 μmol/s

R1=95	R2=99	R3=95	R4=96	R5=98	R6=90	R7=86	R8=75
R9=56	R10=98	R11=96	R12=80	R13=98	R14=98	R15=86	Re=90



**L.T.F.**

**QLUX COB LED Series**



**QLUXCOBI181893016KWD-PH1CH**  
**Single Channel Dim to Warm Chip on Board LED**

**IES TM30-18 COLOR RENDERING REPORT**

1800K CCT (10mA, Full Dimming,  $T_j=25^\circ\text{C}$ )

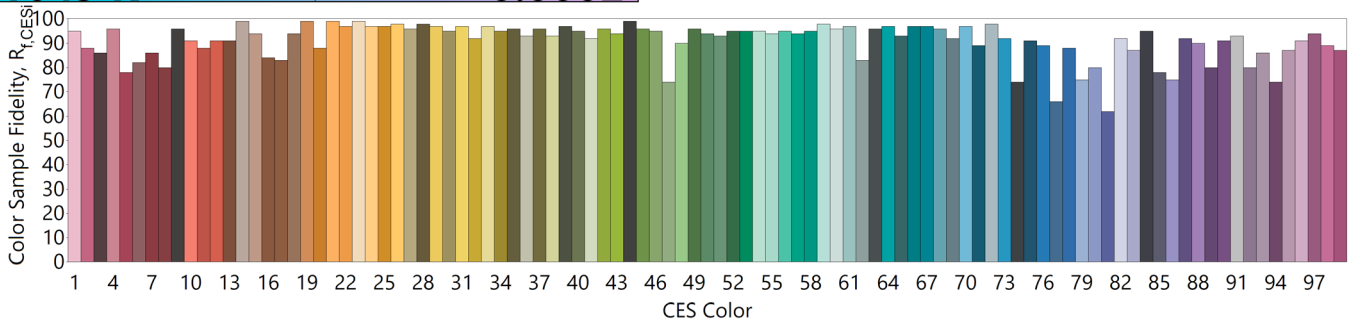
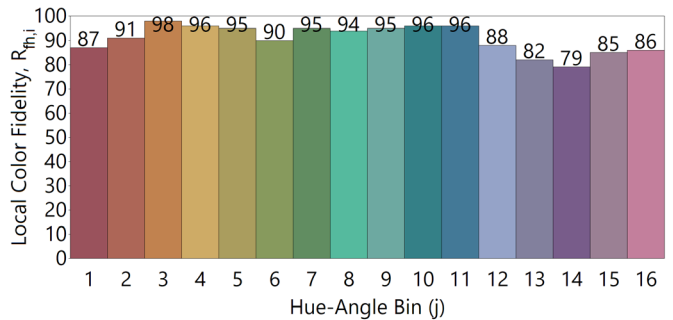
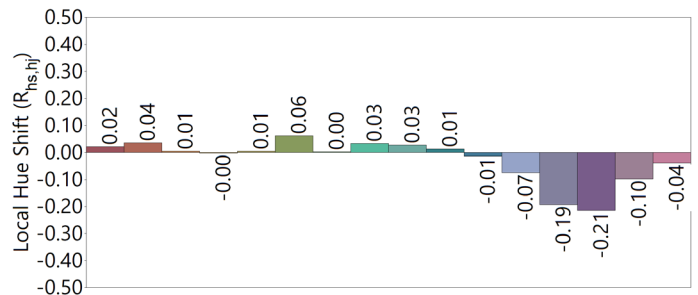
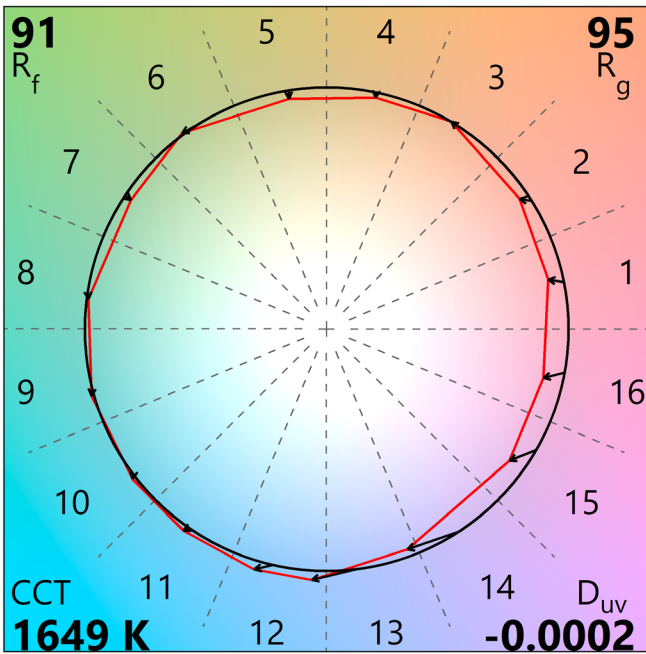
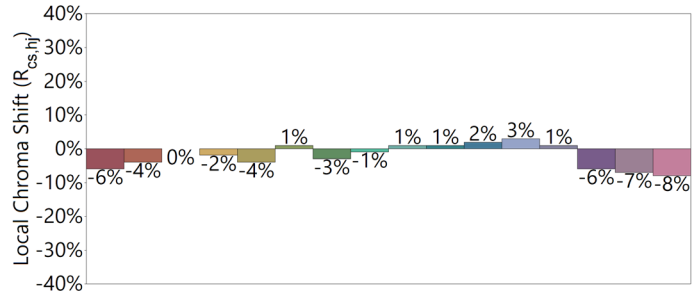
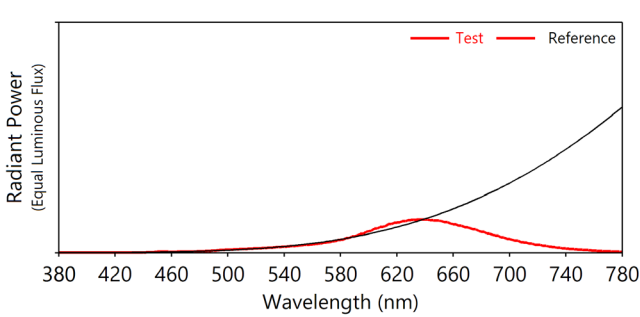



**L.T.F.**

**QLUX COB LED Series**



**QLUXCOBI181893016KWD-PH1CH**  
**Single Channel Dim to Warm Chip on Board LED**

**PERFORMANCE CURVES**

Test Condition: 25°C

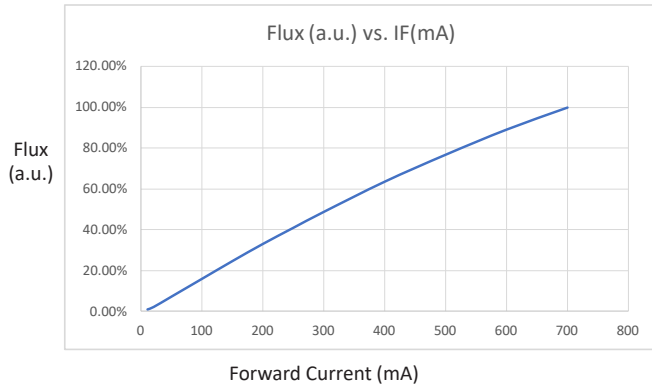

Test Condition: 85°C

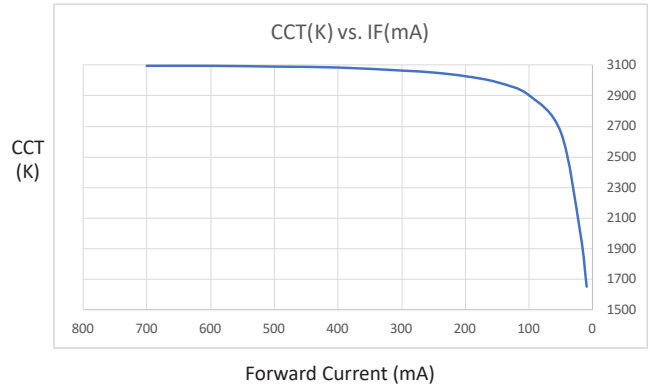

Test Condition: 85°C

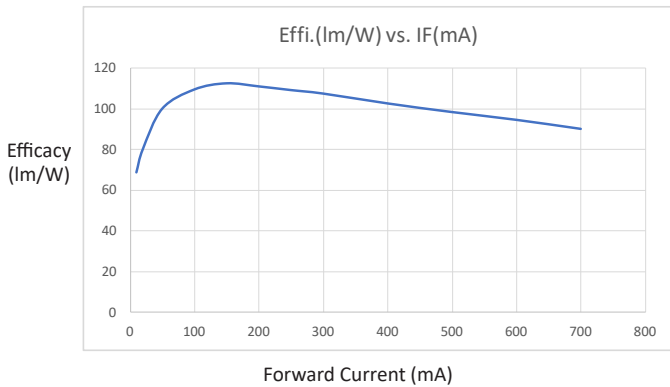

Test Condition: 85°C

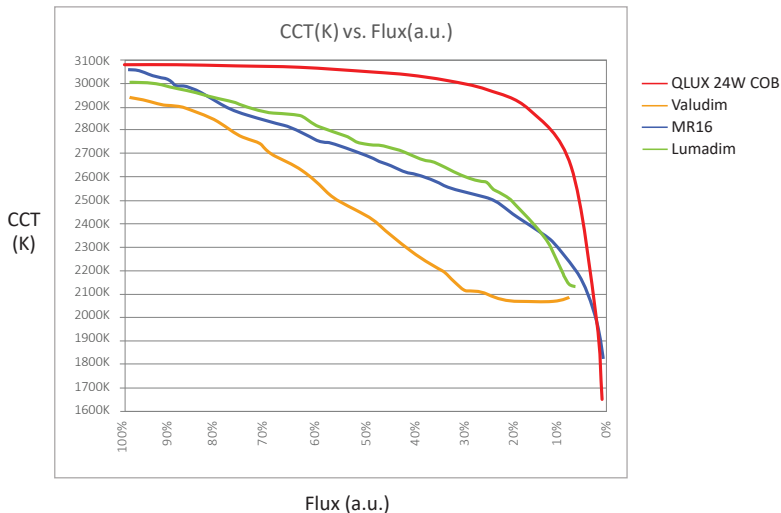
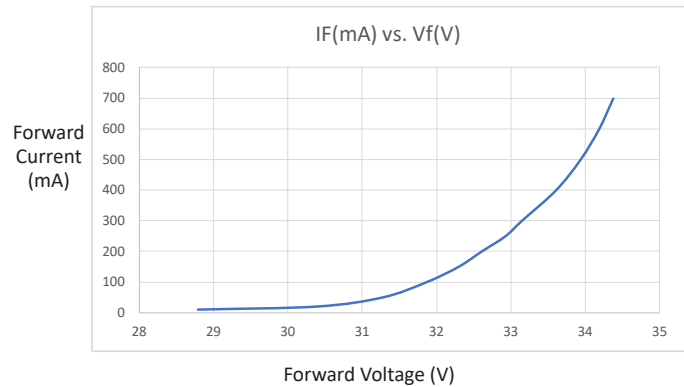



**L.T.F.**

**QLUX COB LED Series**



**QLUXCOBI181893016KWD-PH1CH**  
**Single Channel Dim to Warm Chip on Board LED**

## PRECAUTIONS FOR USE

**Caution:** Do not touch or apply pressure to the light emitting surface (LES) of the COB. Doing so may damage the LED array.

Do not mount reflectors or optics in contact with the LES.

Contact with surfaces of the COB outside of the LES is acceptable for mounting optical devices.

Do not handle COB with bare hands - oils from skin may contaminate the light emitting surface and affect light output.

Apply thermal grease between COB and fixture housing / heat sink to ensure efficient dissipation of excess heat.

Electrostatic discharge (ESD) and excessive transient voltages may damage the COB. Take precautions such as grounded wrist straps and ESD mats when installing / handling the COB.

## STORAGE CONDITION

**Before opening sealed packaging:**

- Temperature 5°-30°C
- Relative humidity less than 60%.

**After opening:**

- Temperature 5°-30°C
- Relative humidity less than 60%.
- Apply solder within one week of opening.
- LED should be kept in moisture proof foil bag with silica gel desiccant packet.

## CHEMICAL COMPATIBILITY

Certain compounds can be absorbed by the resin that encapsulates the light emitting surface, potentially causing reactions that may reduce light output or physically damage the COB. The following compounds are not recommended for use with QLUX COBs:

- Acetates
- Acetic Acid
- Acrylates
- Aldehydes
- Amines
- Benzene
- Dienes
- Ethers
- Cl, F or Br compounds
- Liquid Hydrocarbons
- Ketones
- Nitric Acid
- Phosphoric Acid
- Potassium Hydroxide
- Siloxanes, Fatty Acids
- Sodium Hydroxide
- Sulfur Compounds
- Sulfuric Acid
- Toluene
- Xylenes

## CLEANING

Do not clean COBs with water, benzene and/or thinner. **Use isopropyl alcohol (IPA) only.** If another solvent is used, it may cause the LED package / resin to be damaged. Do not clean COBs with an ultrasonic cleaner.

To clean the COB, moisten a clean non-abrasive cloth with isopropyl alcohol, avoiding excess liquid / drips. Gently wipe COB surfaces (**Do not apply pressure to the light emitting surface**) to remove any dust, finger prints, etc..